

# MARK 4 12-BUTTON POST MIX MANIFOLD

JOB:

ITEM#:

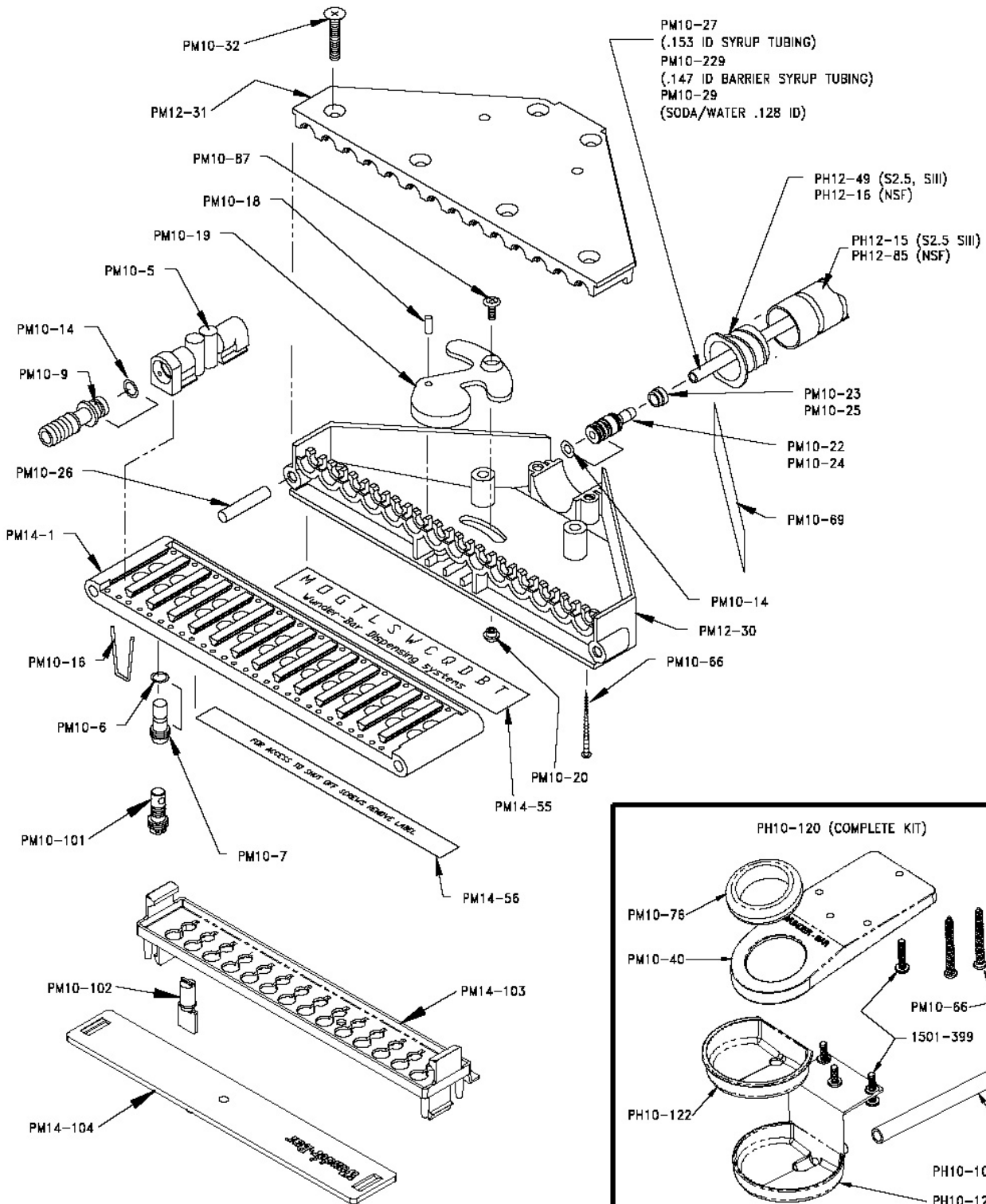

0550079.DWG / 05 APR 2010

## Wunder-Bar Dispensing Systems

AUTOMATIC BAR CONTROLS, INC.  
790 EUBANKS DRIVE  
VACAVILLE, CA 95688

PHONE: (707) 448-5151  
FAX : (707) 448-1521  
[www.wunderbar.com](http://www.wunderbar.com)